

VENUS (QPSS)

The QPSS cable cleats are metallic cable cleats which have been designed, constructed, and tested in accordance with the International Standard IEC 61914: Cable cleats for electrical installations, to ensure the securing and retention of cables, without sustaining damage to the cable.

The range is fabricated from 316L stainless steel, giving it high creep strength whilst providing excellent corrosion resistance in the harshest of environments.

The cleat has one M8 coach bolt fixing hole integrated into the C-Clamp allowing versatility to the installer during installation.

Liners come as standard which help to restrain the cable(s) within vertical applications. Where thermal elongation of cables occurs, the liner also provides a layer of protection between the cable sheath and the cable cleat during normal operation. This additional layer protects the cable from chafing on any mounting surface due to differential movements such as those found in marine and offshore applications. The liners also assist in the extra protection of cable(s) in the event of short circuit fault conditions. The standard liners supplied are classified as Low Smoke and Fume Zero Halogen (LSFOH), Phosphorus-free.

FEATURES

- Third party certification to IEC 61914
- 316L stainless steel
- For Quadruplex/standard quad formation
- Operating temperature -50°C to +60°C or -58°F to +140°F
- Liners are classified as Low Smoke and Fume Zero Halogen (LSFOH), Phosphorus-free

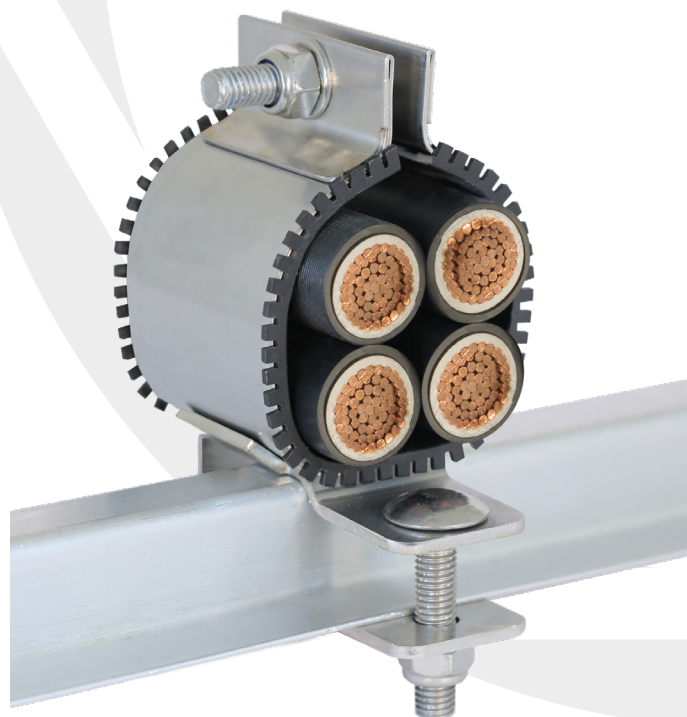

Ladder rung shown as example.

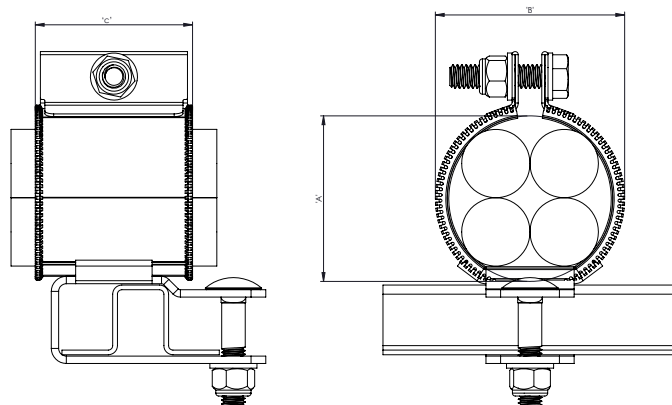

CABLE CLEAT SELECTION TABLE

QUAD PART NO.	QUAD PLEX Ø RANGE 'A' (mm)		CLEAT WIDTH 'B' (mm)	CLEAT DEPTH 'C' (mm)	WEIGHT (g)	FIXING HOLE Ø
	MIN Ø	MAX Ø				
QPSS-18	16.5	19.5	29.5	33.5	184	1 x M8
QPSS-19	17.5	20.5	30.5	33.5	187	1 x M8
QPSS-20	18.5	21.5	31.5	33.5	188	1 x M8
QPSS-21	19.5	22.5	32.5	33.5	190	1 x M8
QPSS-22	20.5	23.5	33.5	33.5	192	1 x M8
QPSS-24	22.5	25.5	35.5	33.5	194	1 x M8
QPSS-26	24.5	27.5	37.5	33.5	202	1 x M8
QPSS-28	26.5	29.5	39.5	33.5	205	1 x M8
QPSS-30	28.5	31.5	41.5	33.5	207	1 x M8
QPSS-32	30.5	33.5	43.5	33.5	210	1 x M8
QPSS-34	32.5	35.5	44.5	33.5	213	1 x M8
QPSS-36	34.5	37.5	47.5	33.5	216	1 x M8
QPSS-38	36.5	39.5	49.5	33.5	218	1 x M8
QPSS-40	38.5	41.5	51.5	33.5	218	1 x M8
QPSS-42	40.5	43.5	50.5	33.5	218	1 x M8
QPSS-44	42.5	45.5	55.5	33.5	220	1 x M8
QPSS-46	44.5	47.5	57.5	33.5	223	1 x M8
QPSS-48	46.5	49.5	59.5	33.5	226	1 x M8
QPSS-50	48.5	51.5	61.5	33.5	229	1 x M8
QPSS-51	49.5	52.5	62.5	33.5	232	1 x M8
QPSS-52	50.5	53.5	63.5	33.5	235	1 x M8
QPSS-54	52.5	55.5	65.5	33.5	238	1 x M8
QPSS-56	54.5	57.5	67.5	33.5	290	1 x M8
QPSS-58	56.5	59.5	69.5	33.5	293	1 x M8
QPSS-60	58.5	61.5	71.5	33.5	296	1 x M8

Dimensions are displayed in millimeters unless otherwise stated

Order reference examples: When ordering, please add rung type as suffix. For example, QPSS-26 for installation on rung B, please add suffix -B (QPSS-26-B). All rung types can be found on second page.

TECHNICAL DATA & CLASSIFICATION

TYPE	6.1.3 Composite QPSS - Standard Duty Stainless Steel
DESIGN SPECIFICATION	IEC 61914
TEMPERATURE FOR PERMANENT APPLICATION	-50°C to +60°C IEC 61914 clause 6.2
NEEDLE FLAME TEST	Pass - 120 second flame application time IEC 61914 clause 10.0, 10.1, IEC 60695-11-5
LATERAL LOAD TEST	Refer to CMP Products, IEC 61914 clause 9.3
AXIAL LOAD TEST	Refer to CMP Products, IEC 61914 clause 9.4
IMPACT RESISTANCE	Pass - Very heavy IEC 61914 clause 6.3, 6.3.5, 9.2
MATERIAL	316L Stainless Steel with Standard Liners Standard liners are classified as Low Smoke and Fume Zero Halogen (LSFOH) and Phosphorus-free

SHORT CIRCUIT TESTING TO IEC 61914 - CLAUSE 9.5

QUAD FORMATION			
Two short circuits 300mm fixed cleat centres	Two short circuits 600mm fixed cleat centres	One short circuit 600mm fixed cleat centres	Two short circuits 600mm fixed cleat centres with intermediate restraints
0.1sec	0.1sec	1Sec	0.1Sec
135kA Peak	79.5kA Peak	62kA Peak	100kA Peak
61.3kA r.m.s	37.8kA r.m.s	29.5kA r.m.s	47.6kA r.m.s

HOW TO ORDER

Take 'PLEXED' cable enveloping diameter (dimension 'A') I.E 90mm = QPSS-90
If the rung is one of the standard rungs shown below then add the letter for that rung:

For **QUADPLEX** on rung type A = QPSS-90-A

If the rung is size is not shown then the code can be generated referencing the dimensions of the rung:

Example: RUNG WIDTH (W) = 40mm
RUNG HEIGHT (H) = 24mm

For **QUADPLEX** application = QPSS-90-40-24

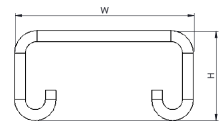

- Identify ladder type (refer to line drawings in section below).

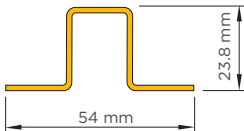

1. RUNG DIMENSION CODES

		RUNG A	RUNG B	RUNG C	RUNG D
HEIGHT	INCHES	0.500"	0.9375"	1"	0.8125"
	mm	12	23.8	25.4	20.6
WIDTH	INCHES	2.125"	2.125"	1"	1.625"
	mm	54	54	25.4	41.2

Ladder types shown are typical examples, if you have a different type please contact CMP directly. Bespoke sizes available on request.

- Identify required cleat size (refer to cable cleat selection table).

- Ladder / Strut / Mounting Surface
- C-Clamp

2. QPSS ORDERING CODES

QUAD CABLE Ø RANGE TAKE	QUAD PART No.	RUNG A	RUNG B	RUNG C	RUNG D
17.5 - 20.5	19	QPSS-19-A	QPSS-19-B	QPSS-19-C	QPSS-19-D
19.5 - 22.5	21	QPSS-21-A	QPSS-21-B	QPSS-21-C	QPSS-21-D
22.5 - 25.5	24	QPSS-24-A	QPSS-24-B	QPSS-24-C	QPSS-24-D
24.5 - 27.5	26	QPSS-26-A	QPSS-26-B	QPSS-26-C	QPSS-26-D
34.5 - 37.5	36	QPSS-36-A	QPSS-36-B	QPSS-36-C	QPSS-36-D
36.6 - 39.5	38	QPSS-38-A	QPSS-38-B	QPSS-38-C	QPSS-38-D
40.5 - 43.5	42	QPSS-42-A	QPSS-42-B	QPSS-42-C	QPSS-42-D
54.5 - 57.5	56	QPSS-56-A	QPSS-56-B	QPSS-56-C	QPSS-56-D
56.5 - 59.5	58	QPSS-58-A	QPSS-58-B	QPSS-58-C	QPSS-58-D
58.5 - 61.5	60	QPSS-60-A	QPSS-60-B	QPSS-60-C	QPSS-60-D

RUNG TYPE

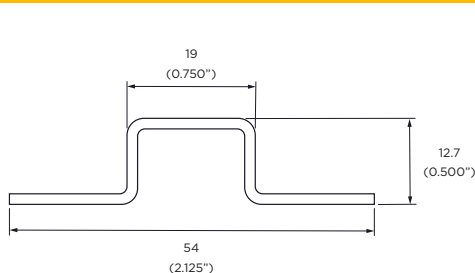

RUNG A

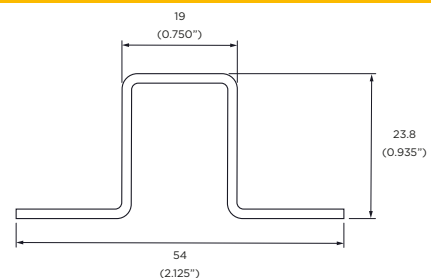

RUNG B

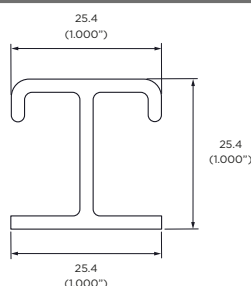

RUNG C

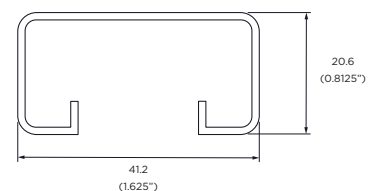

RUNG D

Dimensions are displayed in millimetres unless otherwise stated.